

OPERATING AND INSTALLATION INSTRUCTIONS



**Air-Operated
Diaphragm Pumps
made of conductive
Polyethylene**

**CXM
Series**



Pump sizes 10/20/50/130 (NPT)

Pump sizes 25/55/135 (BSP)



Original Instruction
Read carefully before pump installation

CONTENTS

	Page
Introduction	3
General description of the machine, appropriate use and residual dangers	3
Storage and long-term usage	3
Code system	4
Operation in explosion proof areas	5
Special Operations Conditions	5
Atex Marking for Gases and Dusts in Accordance to 2014/34/EU	6
Technical data	7
Dimensions	8
Performance charts	9
Installation	12
Recommended installation	12
Start-up operation	12
Torque values	13
Safety instructions	13
Using as submersible pump	15
Additional temperature hints	15
Disassembly and assembly advises	16
Trouble shooting	17
Spare part list	19
Special equipment	20
Exploded views	21
CXM 10/20/50/130	21
CXM 25/55/135	22

INTRODUCTION

ALMATEC air-operated diaphragm pumps are constructed according to the state of the art and they are reliable. Imminent danger by operating error or misuse can lead to damages of properties and/or persons. The pumps are to be applied for the intended use and in a safety-related proper condition only.

Each person working on the ALMATEC air-operated diaphragm pumps concerning installation, start-up, handling or maintenance has to read this manual completely and in an attentive way and has to follow all mentioned procedures and safety notes.

GENERAL DESCRIPTION OF THE MACHINE, APPROPRIATE USE AND RESIDUAL DANGERS

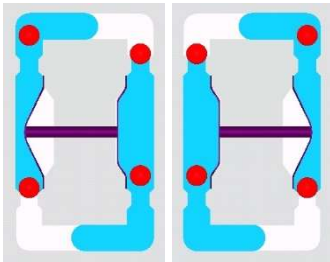

The ALMATEC CXM pumps are oscillating positive displacement pumps and are based on the functional principle of double diaphragm pumps. The basic configuration consists of two external side housings with a center housing between them. Each of the side housings contains a product chamber which is sealed against the center housing by a diaphragm. The two diaphragms are interconnected by a piston rod. Directed by an air control system, the diaphragms are alternately loaded with compressed air so that they move back and forth. In the first figure, the compressed air has forced the left-hand diaphragm towards the product chamber and displaced the liquid from that chamber through the open valve at the top to the discharge port. Liquid is simultaneously drawn in by the right-hand diaphragm, thus refilling the second product chamber. When the end of the stroke is reached, it reverses automatically, and the cycle is repeated in the opposite direction. In the second figure, liquid is drawn in by the left-hand diaphragm and displaced by the right-hand diaphragm.

The appropriate use of an Almatec air-operated diaphragm pump refers to the liquid transport taking into account the operation parameter mentioned in this manual and in compliance of the given terms for commissioning, operation, assembly, disassembly and maintenance.

Even if all necessary safety measures described in this manual have been met, a residual danger exists by leakages or mechanical damages. At sealing areas or connections liquid can be released uncontrollably then.

STORAGE AND LONG-TERM USAGE

In general, the ALMATEC pump is delivered operational and packaged. If the unit is not installed right away, proper storage conditions are important for a trouble-free operation later. The pump must be protected from wetness, coldness, dirtying, UV-radiation and mechanical influences. The following storage conditions are recommended:

- Steady ventilated, dust and vibration free storage room
- Ambient temperature between 15°C and 25°C with a relative humidity below 65%
- Prevention of direct thermal influences (sun, heating)

Plastic materials are subject to aging processes depending on material, surrounding conditions and application parameters. Chemical contact and/or increased temperature can amend material characteristics on the long run, especially mechanical capabilities. For safety reasons, we do therefore recommend as part of every maintenance (resp. in case of no maintenance till then after two years and then every six month): A careful visual check of all pump parts for visible damages, a tactile check of all sealing surface (e.g. by moving a finger along the surface after cleaning), a shape-check of the housing parts (e.g. by laying a drawer on plain surfaces) and a movability check of all threads. Any eventually damaged part needs to be replaced!

CODE SYSTEM

PSG Germany GmbH is certified as a modern, quality-orientated enterprise according to DIN EN ISO 9001 and 14001. Before release for dispatch, any pump must undergo an extended final control.

As a general rule in the countries of the EU only such machines are allowed to take into operation, which are determined to meet the regulations of the EU machinery directive, the harmonized standards, European standards and the respective national standards. Hence the operator must verify whether the ALMATEC pump manufactured and delivered properly according to the customer's order meets the mentioned requirements.

Therefore, make sure, before putting the pump into operation, that the pump and the used materials of construction are suitable for the provided application and the installation site. To check this, the exact pump code is required. This code, the serial number and the year of construction are noted on the identification plates on the pump itself.

Example to clarify the ALMATEC CXM pump code:

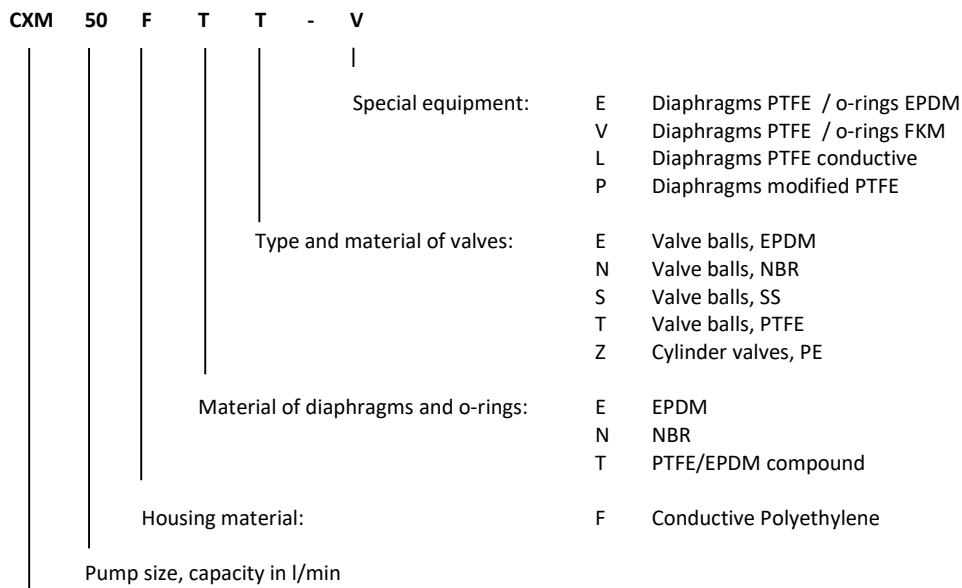

ALMATEC air-operated double diaphragm pump, CXM series

OPERATION IN EXPLOSION-PROOF AREAS AND FOR FLAMMABLE LIQUIDS

X = CAUTION! = Special operating conditions apply!

For pumping flammable liquids or in Ex-areas, only pumps with housing parts and internals made of conductive plastic may be used. Air-operated diaphragm pumps of the CXM series with housing code F (PE conductive) meet this requirement. They must generally be grounded via a connection on the right sidehousing [1]. The ground connection must have a minimum cross-section of 6 mm². All other housing parts are conductive and connected to each other.

ALMATEC air-operated diaphragm pumps made of electrically conductive PE/PTFE are suitable for use in potentially explosive atmospheres of category 2 and 3 ("Zone 1" and "Zone 2" respectively), atmosphere G/D, which are subject to the scope of EU Directive 2014/34/EU. Conductive diaphragms (material code 68, 70, 72) can be used without restriction for pumping liquids in all explosion groups. If non-conductive diaphragm materials are used (material code 67, 98), explosion group IIB applies within the pump for pump size CXM 10 up to including CXM 135 (regardless of the installation site).

Pipelines and product connections must be grounded separately. To avoid ignition hazards, the formation of dust deposits on the units must be prevented. Repairs in hazardous areas may only be carried out after careful examination of the feasibility and only with appropriate tools and by trained specialist personnel.

The ATEX marking according to Directive 2014/34/EU can be found in the enclosed Declaration of Conformity and the corresponding sticker on the pump or damper.

The interfaces for electrical accessories have been considered and do not represent a new potential ignition source.

The type of protection "**c = design safety**" was applied in accordance with guideline EN ISO 80079-37.

SPECIAL CONDITIONS	CXM 10	CXM 20/25	CXM 50/55	CXM 130/135
Permissible ambient temperature (°C) [F]	-10 – 50 [14 – 122]			
Permissible temperature of driving air (°C) [F]	0 – 50 [32 – 122]			
Maximum driving/operating pressure (bar) [psi]	7 [101]			
Maximum driving/operating temperature (X):				
PE(°C) [F]:	70 [158]	70 [158]	70 [158]	70 [158]

ATEX MARKING FOR GASES AND DUSTS IN ACCORDANCE TO 2014/34/EU

In order to enable the optimum and flexible design of an ATEX pump to the customer-specific application, a differentiation is made in the marking between the installation location of the pump (hazardous area outside the pump) and the inside of the pump (hazardous area inside the pump).

Equipment category G (gases, mists, vapors)

Installation site: Category G

Inside the pump: Category G

Conductive ALMATEC air-operated diaphragm pumps may generally be used in explosion group IIC at the installation site (potentially explosive area outside the pump), since the solid housings are made of dissipative materials and the entire pump is grounded.

ATTENTION! Inside the pump, the permitted explosion group varies depending on the diaphragm material used:

When using *non-conductive diaphragms*, explosion group IIB applies inside the pump:

⊕ II 2/2 G Ex h IIB/IIC T6...T4 Gb/Gb X (inside the pump/installation site)

When using *conductive diaphragms*, explosion group IIC applies inside the pump:

⊕ II 2/2 G Ex h IIC/IIC T6...T4 Gb/Gb X (inside the pump/installation site)

Equipment category D (dusts)

Installation site: Category D

Inside the pump: Category G

Conductive ALMATEC air-operated diaphragm pumps may generally be used in dust group IIIC at the installation site (potentially explosive area outside the pump; equipment category D).

ATTENTION! Inside the pump (equipment category G), the approved explosion group varies depending on the diaphragm material used:

When using *non-conductive diaphragms*, explosion group IIB applies inside the pump:

⊕ II 2/2 D Ex h IIB/IIIC T 70°C...130°C Gb/Db X (inside the pump/installation site)

When using *conductive diaphragms*, explosion group IIC applies inside the pump:

⊕ II 2/2 D Ex h IIC/IIIC T 70°C...130°C Gb/Db X (inside the pump/installation site)

TECHNICAL DATA

NPT port connections		CXM 10	CXM 20	CXM 50	CXM 130
Dimensions, mm (in.):	length	86 (3.4)	124 (4.9)	175 (6.9)	240 (9.4)
	width	134 (5.3)	151 (5.9)	201 (7.9)	265 (10.4)
	height	90 (3.5)	123 (4.8)	167 (6.6)	217 (8.5)
Nominal port size	NPT	3/8"	1/2"	3/4"	1 1/4"
Air connection	BSP	1/4"	1/4"	1/4"	1/4"
Weight, kg (lb)		1 (2.2)	1.8 (3.8)	4.7 (10.4)	11 (24)
Max. particle size of solids for pumps with ball valves	mm (in.)	1.5 (0.06)	2 (0.08)	3 (0.12)	4 (0.16)
Suction lift dry, mWC (ft):	cylinder valves	0.7 (2.3)	2 (6.6)	4.5 (14.8)	4.5 (14.8)
	EPDM ball valves	0.5 (1.6)	1 (3.3)	3 (9.9)	3 (9.9)
	PTFE ball valves	0.5 (1.6)	1 (3.3)	2 (6.6)	3 (9.9)
	SS ball valves	0.5 (1.6)	1 (3.3)	2 (6.6)	3 (9.9)
Suction lift wet, mWC (ft)		8 (26.3)	8 (26.3)	9 (29.5)	9 (29.5)
Sound pressure level acc. to DIN 45635, part 24, depending on the operating data [dB (A)]:					
driving pressure 3 bar		68-70	68-70	68-71	69-71
driving pressure 5 bar		71-74	71-73	73-75	71-75
driving pressure 7 bar		71-76	72-75	74-78	73-76

BSP port connections		CXM 25	CXM 55	CXM 135
Dimensions, mm (in.):	length	124 (4.9)	180 (7.1)	245 (9.7)
	width	151 (5.9)	201 (7.9)	265 (10.4)
	height	123 (4.8)	167 (6.6)	217 (8.5)
Nominal port size	BSP	1/2"	1"	1 1/2"
Air connection	BSP	1/4"	1/4"	1/4"
Weight, kg (lb)		1.8 (3.8)	4.7 (10.4)	11 (24)
Max. particle size of solids for pumps with ball valves	mm (in.)	2 (0.08)	3 (0.12)	4 (0.16)
Suction lift dry, mWC (ft):	cylinder valves	2 (6.6)	4.5 (14.8)	4.5 (14.8)
	EPDM ball valves	1 (3.3)	3 (9.9)	3 (9.9)
	PTFE ball valves	1 (3.3)	2 (6.6)	3 (9.9)
	SS ball valves	1 (3.3)	2 (6.6)	3 (9.9)
Suction lift wet, mWC (ft)		8 (26.3)	9 (29.5)	9 (29.5)
Max. operating temperature, °C (F)		70 (158)	70 (158)	70 (158)
Sound pressure level acc. to DIN 45635, part 24, depending on the operating data [dB (A)]:				
driving pressure 3 bar		68-70	68-71	69-71
driving pressure 5 bar		71-73	73-75	71-75
driving pressure 7 bar		72-75	74-78	73-76

DIMENSIONS

CXM 10, 20, 50, 130

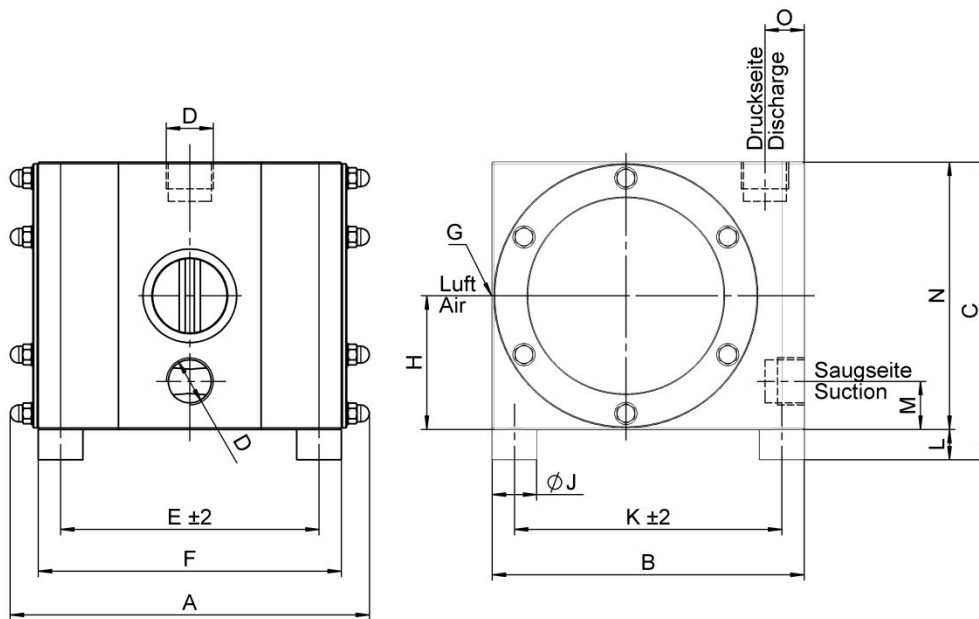

CXM 25, 55, 135

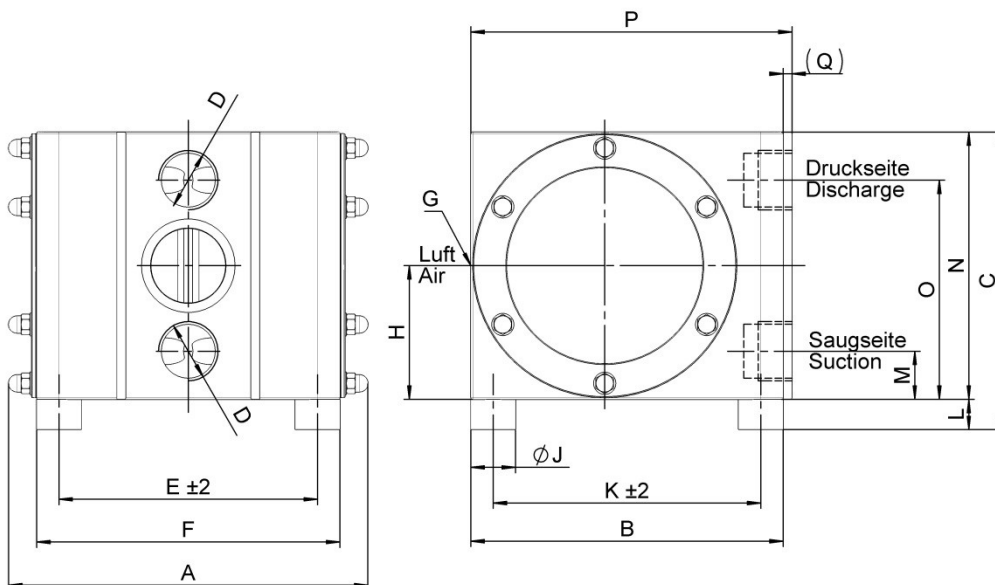

Please see page 9 for the „inch dimension tab“.

mm	A	B	C	D	E	F	G	H	J	K	L	M	N	O	P	Q
CXM 10	134	86	90	NPT 3/8"	98	113	BSP 1/4"	41	15	71	8	14	82	15	-	-
CXM 20	151	124	123	NPT 1/2"	101	126	BSP 1/4"	53	25	99	17	19	106	19	-	-
CXM 25	151	124	123	BSP 1/2"	101	126	BSP 1/4"	53	25	99	17	19	106	87	124	0
CXM 50	201,5	175	167	NPT 3/4"	145	170	BSP 1/4"	75	25	150	17	27	150	22	-	-
CXM 55	201,5	175	167	BSP 1"	145	170	BSP 1/4"	75	25	150	17	27	150	123	175	5
CXM 130	265	240	217	NPT 1 1/4"	200	225	BSP 1/4"	100	25	215	17	37	200	33	-	-
CXM 135	265	240	217	BSP 1 1/2"	200	225	BSP 1/4"	100	25	215	17	37	200	163	245	5

Dimensions in inch (see page 8 for the drawing)

inch	A	B	C	D	E	F	G	H	J	K	L	M	N	O	P	Q
CXM 10	5.3	3.4	3.5	NPT 3/8"	3.9	4.5	BSP 1/4"	1.6	0.6	2.8	0.3	0.6	3.2	0.6	-	-
CXM 20	5.9	4.9	4.8	NPT 1/2"	4.0	5.0	BSP 1/4"	2.1	1.0	3.9	0.7	1.9	4.2	0.8	-	-
CXM 25	5.9	4.9	4.8	BSP 1/2"	4.0	5.0	BSP 1/4"	2.1	1.0	3.9	0.7	1.9	4.2	3.4	4.9	0
CXM 50	7.9	6.9	6.6	NPT 3/4"	5.7	6.7	BSP 1/4"	3.0	1.0	5.9	0.7	1.1	5.9	0.9	-	-
CXM 55	7.9	6.9	6.6	BSP 1"	5.7	6.7	BSP 1/4"	3.0	1.0	5.9	0.7	1.1	5.9	4.8	6.9	0.2
CXM 130	10.4	9.4	8.5	NPT 1 1/4"	7.9	8.9	BSP 1/4"	3.9	1.0	8.5	0.7	1.5	7.9	1.3	-	-
CXM 135	10.4	9.4	8.5	BSP 1 1/2"	7.9	8.9	BSP 1/4"	3.9	1.0	8.5	0.7	1.5	7.9	6.4	9.7	0.2

PERFORMANCE CHARTS

The data refer to water (20°C/68°F), under using of a compressor Atlas Copco VSG30 and calibrated measuring equipment. The specified performance data are warranted by ALMATEC in accordance with DIN EN ISO 9906.

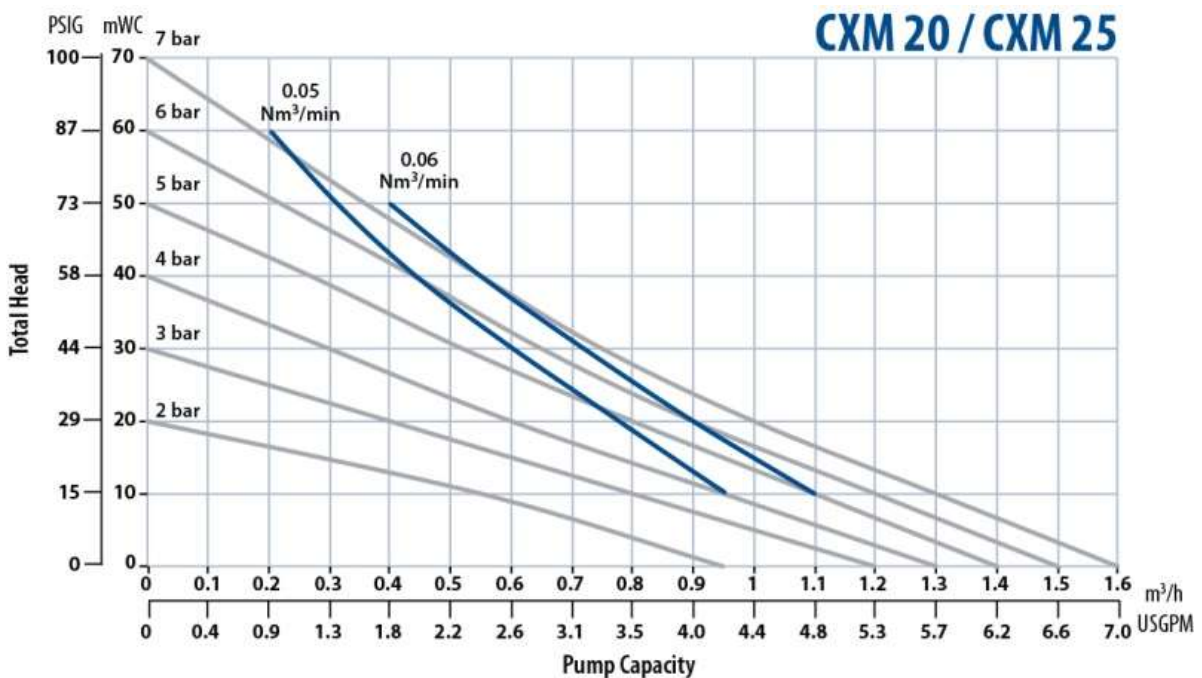
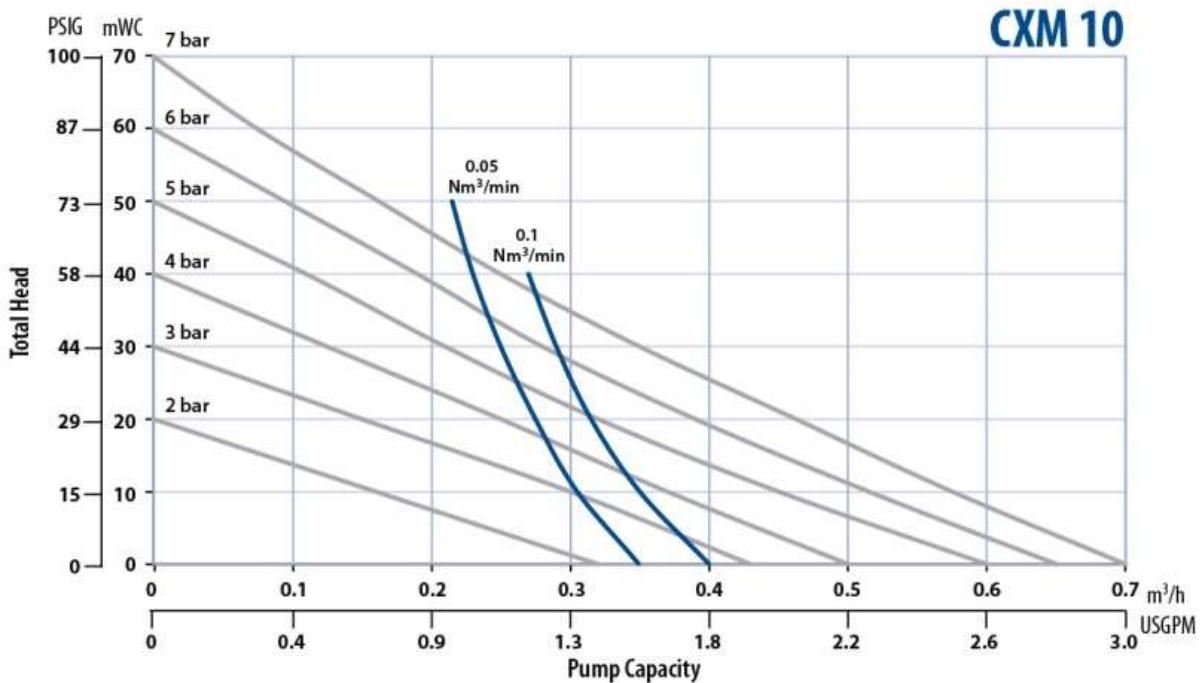

CXM 50

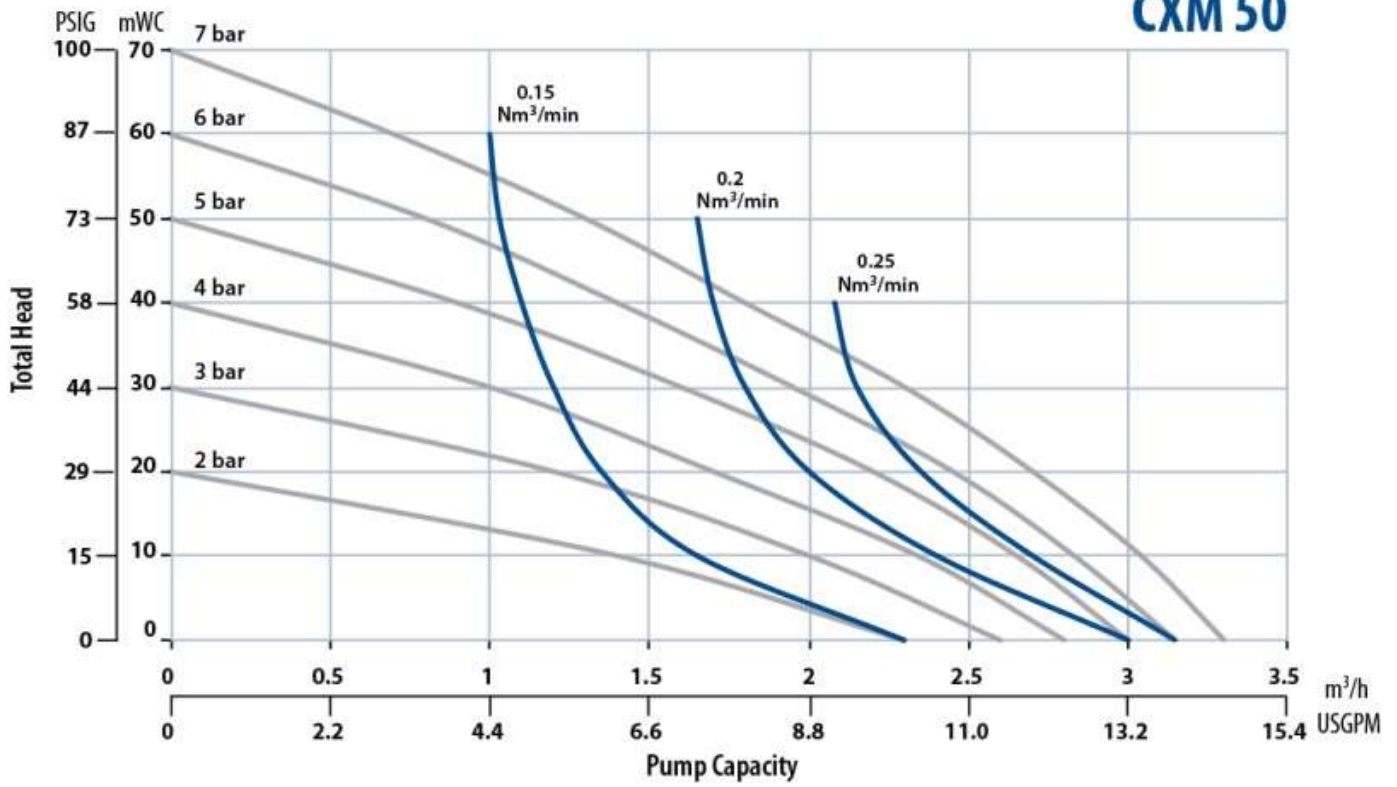

CXM 55

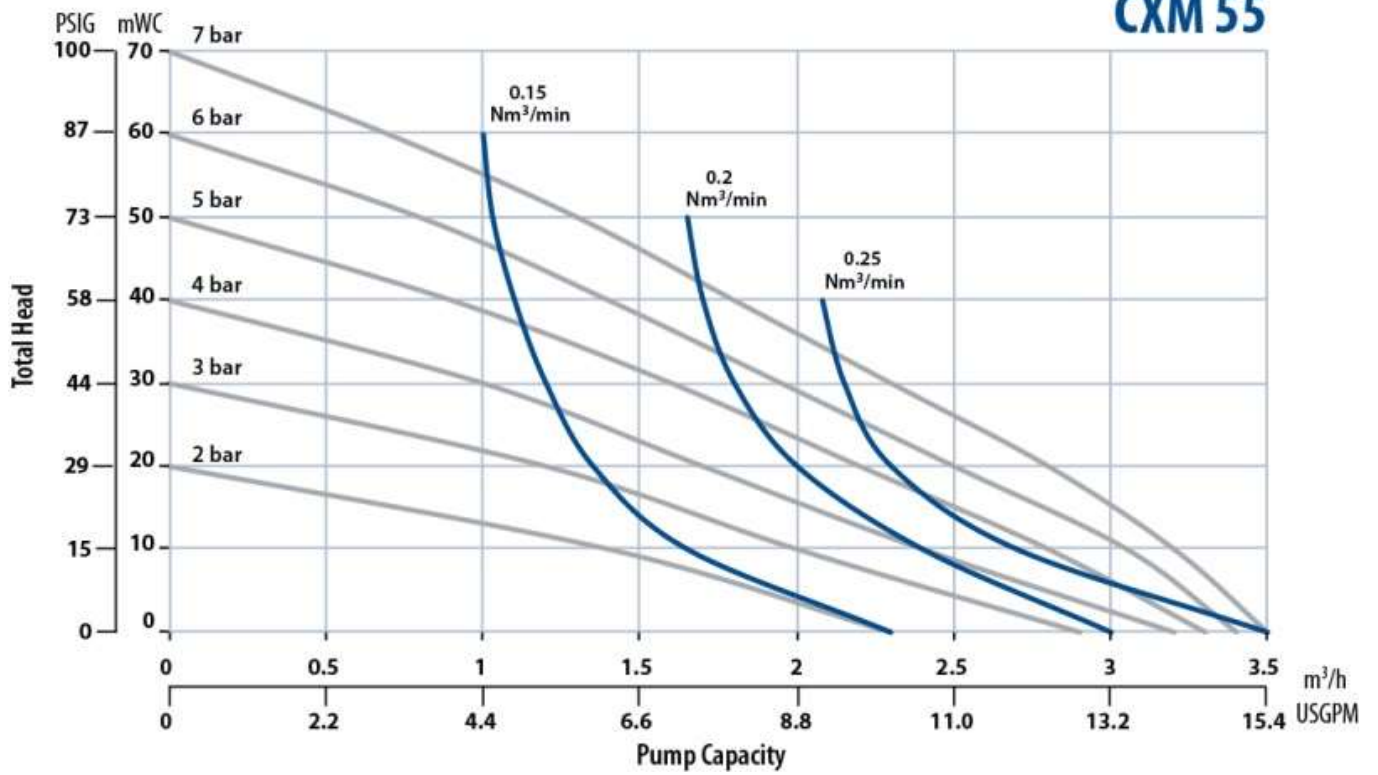

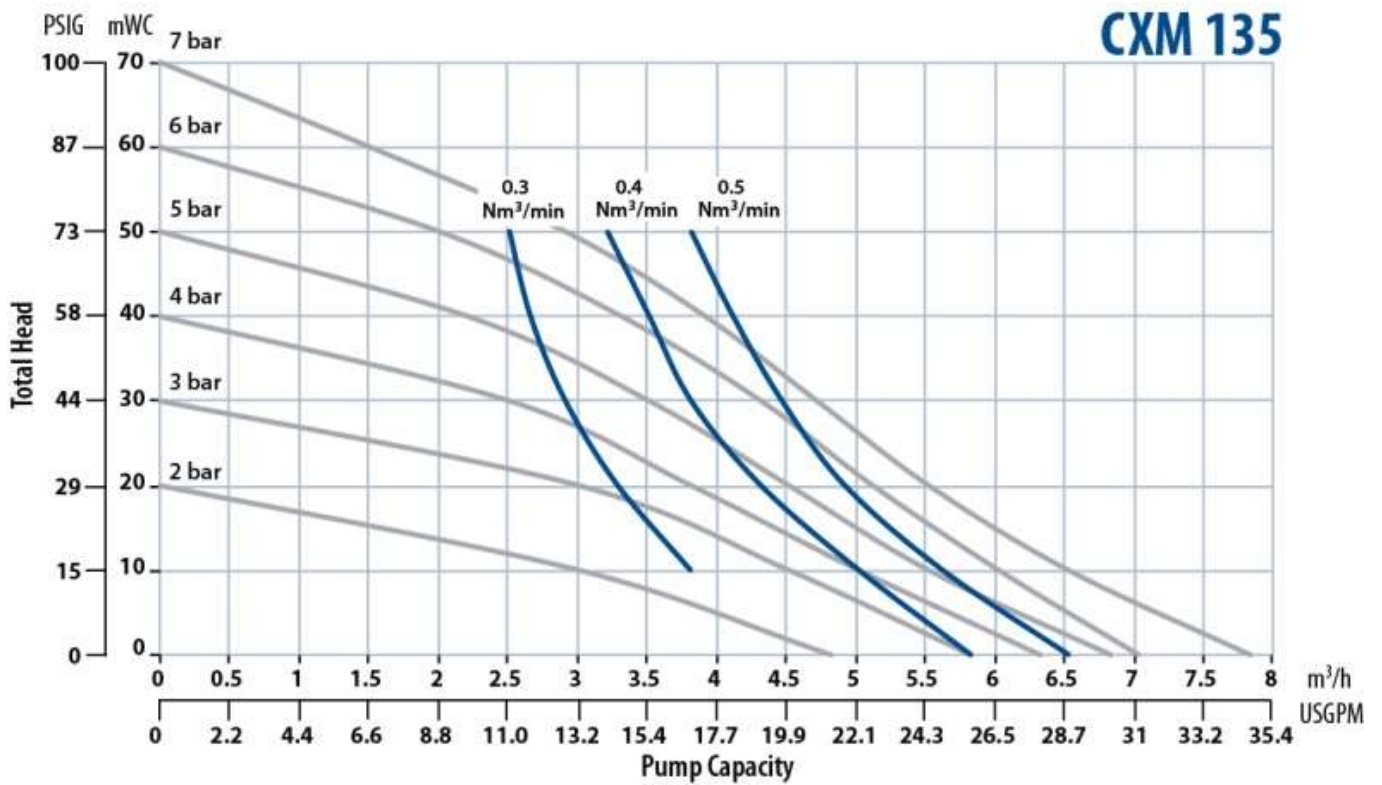
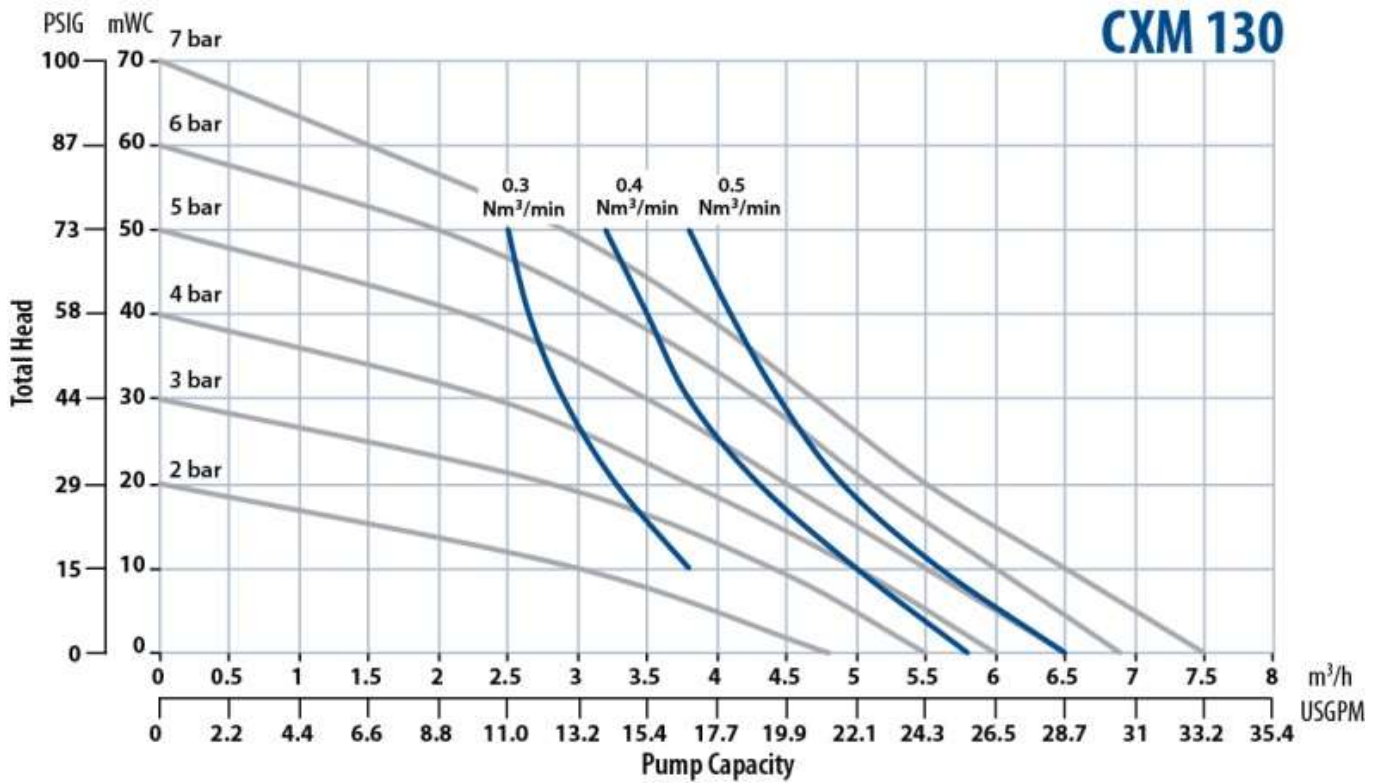

INSTALLATION

Recommended installation

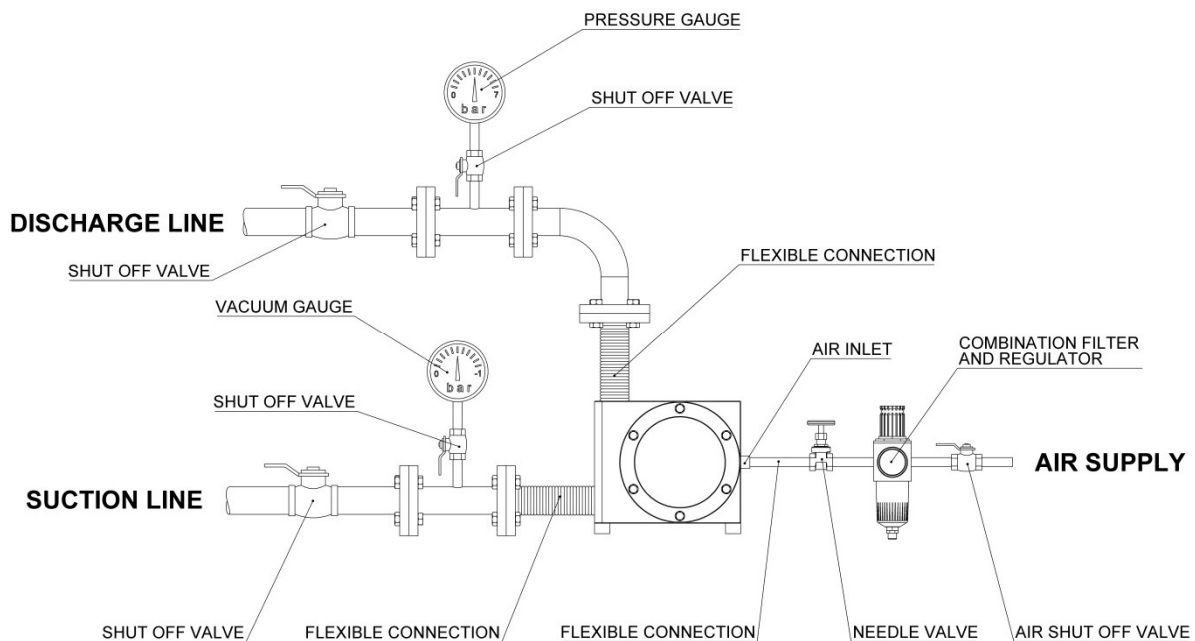

(Example for a CXM 50 with standard product connection positions)

Start-up operations

In general, the pump has to be connected load free. Neglecting this causes leakage and maybe even damages. To avoid vibrations, pulsation dampers and compensators are recommended. Before connecting the pump, take the blind plugs out of all connections. The connections of ALMATEC CXM pumps have slightly tapered threads. Use threadseal only sparingly, otherwise the connections could be damaged.

Port positions CXM pumps with NPT product connections (pump sizes 10/20/50/130)

On delivery, the liquid connections of all CXM pumps are situated as follows:

Suction port "face side horizontal", discharge port "upper side vertical" (see illustration)

By turning the center block by 180° by its longitudinal axis – after unscrewing and taking out the housing bolts – the configuration can be changed to:

Suction port "underside vertical", discharge port "face side horizontal"

Port positions CXM pumps with BSP product connections (pump sizes 25/55/135)

The product connections are both on the face side as follows:

Suction port "face side at the bottom", discharge port "face side on the top" (see illustration)

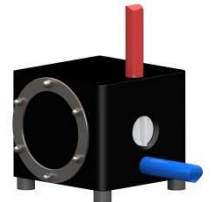

The operator is responsible for an adequately stability and an appropriate fixation of the piping according to the state of the art. To facilitate the installation and maintenance shut off valves should be installed right before and after the pump. The nominal width of the connection pipes has to be chosen in accordance to the connections of the pump. A smaller piping can cause cavitation (suction line) as well as a loss of performance (suction and discharge line). In case the pipe is too big, the dry suction capacity of the pump can decrease. Seal the suction line diligently; hosepipes should be suitably armoured. A suction line continuously rising will prevent the formation of air locks in the line which would affect the suction lift.

The air inlet is located at the front of the pump in the middle of the center housing [2]. When delivered it is covered by a bilingual sticker with safety instructions, which can be easily removed. Before installation make sure that the air supply pipe is free of solids. To supply the pump with driving air sufficiently, the pipe diameter should match the size of the air inlet. Take care that no dirt or particles can intrude into the pump during the connection, as these can accumulate inside the pump and can cause malfunctions. The integrated air control system *PERSWING P®* is a precision-control that requires oil-free, dry and clean compressed air for optimal function. If humidity is expected, a water separator or air dryer has to be fitted to protect the pump from blocking by ice. The ideal condition is the dewpoint of

air at -20°C. In humid surroundings, icing from the outside may occur despite the driving air is dried. If so, a prolonged waste-air-exhaust (ca. 500 mm by pipe or hose) can be helpful. When installing the pump into boards or cabinets, it has to be ensured that cold air does not get caught behind the muffler. In applications with a tendency to freezing at the waste air exhaust, good experiences in practise have been achieved by pre-heating the driving air to increase the distance to the dew point of the air. Doing so, it has to be considered that the driving air temperature generally may not exceed 50°C to avoid expansion and sticking effects on the air side. This max. air temperature is a well valid when using a compressor producing warm air which is e.g. often true for truck compressors.

The pressure of the driving air should be limited to the amount required to meet the performance needed. Excessive pressure increases both the air consumption and the wear of the pump. The pump is regulated by tuning the flow rate of the air. For a proper operation at the lower performance range the regulation via a needle valve is recommended. An empty pump has to be driven slowly (e.g. via a needle-valve). The pump starts automatically. Pumps of the CXM series are self-priming when dry, thus it is not necessary to fill the suction line of the pump. During slow operation of the pump the dry suction lift is better than during high stroke frequency. The suction lift capacity of a liquid-filled pump, however, is much higher. The pump is appropriate for running dry during slow operation. Dry running at high stroke frequency causes premature wear. The pumps can briefly (up to max. one hour) be operated against a closed discharge line. Throttling on the suction side may damage the pump. When the pump operation has been stopped by a closed discharge, the pressure equilibrium of the diaphragms must be ensured. This can be achieved by keeping the pump connected to the air supply pressure; for longer stoppage, the pump must be released from the pressure within the system on both fluid side and air supply side.

Torque values

Size	CXM 10	CXM 20/25	CXM 50/55	CXM 130/135
Torque values for housing bolts (Nm)	3,5	4,5	6,5	8,5

Safety instructions



- Installation, operation, and maintenance by qualified staff only.
- Before putting the pump into operation as well as after some hours of pumping, the housing bolts [9] have to be fixed according to the torque data. Fixing the bolts is necessary as well after longer periods of stoppage, at extreme temperature variations, after transport and dismantling the pump. In case of temperature varying between extremes or high temperature difference between the liquid and the surrounding, the housing bolts should be controlled more frequently (interval proposals are available on request).
- Before start-up of the pump anyone should acquaint oneself with the explanations of the chapter troubleshooting (see pages 14/15). Only by this the defect quickly can be realized and eliminated in case of trouble. Problems which cannot be solved or with an unknown reason should be passed on to the manufacturer.
- Before any maintenance and service procedures arising on the pump or on the optional equipments, the complete installation has to be turned off and protected against accidental turn on. This is possible by a lockable emergency stop for the air supply of the pump. Additional a danger sign against restart should be attached.
- Pressure tests of the plant a pump is included in may only be carried out with the pump disconnected from the pressure on both ports or by using the pressure the pump develops while operating. The load of a pressure in the plant may damage the pump.
- AODD pumps must not be operated with a positive suction pressure.
- Depending on the conditions of operation, the liquid conveyed might escape from the pump through the muffler in case of a diaphragm rupture (in this case muffler has to be replaced). For further safety requirements the optional equipment diaphragm monitoring and barrier chamber system are recommended.
- In case of a diaphragm rupture, it might be possible for the fluid pumped to intrude into the air side of the pump. In very adverse conditions - e.g. pressure within the fluid system during stopped air supply - the fluid might as well find its way into the air supply lines. To protect other devices like pulsation dampers or even pneumatic valves, it is recommended to protect the air supply line accordingly, e.g. via a non-return valve. This would as well avoid polluting the air supply line.

- The state of the muffler has to be inspected regularly, as a blocked muffler can be forced out of the pump. If this happens, damages of properties and/or persons cannot be excluded.
- If the product tends to settle, the pump has to be flushed regularly. For larger solids a filter has to be installed in the suction line.
- In case of delivery of hot liquids the wetted pump must not standstill for a longer time, because it could lead to temporary leaks in the valve area and to a blockade of the air control system.
- The relevant effective security advises have to be respected.
- Pools of liquid which appear in the near outer area of the pump have to be inspected on danger potential, if necessary safety measures are to be taken.
- Chemical and biological reactions in the product chamber of the pump (mixture of different substances) and the freezing of the liquid have to be avoided.
- Before starting to disassemble the pump, take care that the pump has been emptied and rinsed. Both ports piping are to be closed and drained if applicable. Further the pump has to be cut off from any energy on the air and product side. If the pump is being deported from the plant, a reference about the delivered liquid has to be attached. A template is available on the Almatec website.
- Please respect the relevant additional security advices, if the pump has been used for aggressive, dangerous or toxic liquids (e.g. suitable protective equipment according to the safety data sheet of the liquid). In case of a diaphragm rupture, it is possible that residues of the liquid remain behind the diaphragms, in the area of the air control system and at the muffler, despite of several flushing processes. Hence, appropriate safety equipment according to the safety data sheet of the liquid is indispensable.
- Additional advice for handling sensitive Fluids: With correct material choice, all wetted parts inside the pump are made from materials appropriate for your fluid - selected types as well for food contact. A malfunction, however, might result in a contact of the fluid to components that are non-wetted during normal operation (e.g. inside the air section). Therefore, we recommend as usual for pumps, to discard the batch after a malfunction when handling sensitive fluids. Please consider that a conformity for food-contact solely refers to wetted materials themselves, NOT to a "Hygienic Pump Construction".
- Before putting the pump back into operation, the tightness of the pump has to be checked.
- Air-operated diaphragm pumps can lead to bruises when lifting, sinking or assembling them. Appropriate accessories and safety equipment are to be used. Big and heavy modules have to be fixed and secured to lifting gears when transporting/replacing them.
- Especially when deliver critical liquids, wear parts, like diaphragms, should be replaced within a preventive maintenance.
- The use of non-original ALMATEC spare parts and structural changes lead to the lapse of the warranty immediately. When operating such a pump, damages of properties and/or persons cannot be excluded.
- The operation of the pump with nitrogen as driving gas is possible. In closed rooms sufficient ventilation must be provided.
- Possible electrical connections (e.g. when using optional equipment with controllers) may be executed by a qualified person only. The regulations of the respective manufacturers are to be followed.
- At any work arising it has to be made sure that no explosive atmosphere can appear. Appropriate safety equipment is recommended.
- Procedure for pump return: According to the requirements of our 14001-certification, every unit which is send to ALMATEC for diagnosis or maintenance reasons has to be accompanied by a filled out decontamination-sheet. Otherwise a processing is not possible. The decontamination-sheet is enclosed to this manual. Please pay attention to the further safety regulations.

Using as submersible pump

Consider the following advises when using a CXM pump as a submersible pump: When immersing an air- operated diaphragm pump, it must generally be ensured that the waste air is deducted above the fluid level with a pipe or similar. The pump must be located vertically upright to guarantee proper function. Minute leakage on the air inlet or outlet can block the air valve. The pump must be disconnected from the pressure within the system during standstill. When choosing the pump type, it must be taken into consideration that all external parts - even those non-wetted during standard operation - like covers, shock absorbers, connections etc. must be resistant to the fluid pumped. Please consider as well that depending on the material, the pump must be weight down resp. fixed.

Additional temperature hints

The temperature and pressure limitations listed on page 5 are solely based on mechanical temperature limits of the housing material used. Depending on the fluid pumped, the maximum safe operating temperature of the housing material can be reduced significantly.

A general aspect of lower temperatures is, that below 0°C (32°F) cold-brittling of the elastomers used within the pumps can results in accelerated wear. Regarding the housing materials, please note that PE - other than PP - keeps its mechanical strengths at low temperatures and PTFE keeps mechanically stable as well for an extended temperature range. ALMATEC pumps of the CXM series can therefore be operated safely as well within low-temperature installations: However, with liquids below 0°C (32°F) accelerated wear of internal parts has to be accepted. Moreover, freezing, bogging or crystallisation of the fluid pumped must be avoided, especially within the pump.

Please consider, that viscosity and specific gravity of most fluids change with temperature (most often increasing at lower temperature). Depending on the application, this fact may not only result in result in a reduced flow rate, the pump may even be unable to prime the thicker and/or “heavier“ fluid any more.

In case of varying application temperatures, the housing bolt tension has to be controlled very thoroughly, as variations like these can change the effective tension of the housing bolts via the different thermal expansion characteristics of single.

DISASSEMBLY AND ASSEMBLY ADVISES

The general design of the ALMATEC CXM pumps is simple. A plastic tool designed for the mounting of the air control system [22] is delivered along with every pump. Recommend tools are listed below. Please find the part number for any part in the spare part list.

Tool list		Pump size	CXM 10	CXM 20/25	CXM 50/55	CXM 130/135
Pos	Description	Kind of Tool	Tool Size	Tool Size	Tool Size	Tool Size
10	Valve stop	Pin-Wrench	4 mm	5 mm	6 mm	8 mm
12	Housing bolt, cpl.	Open-end/Box Wrench / Socket Spanner	7 mm	8 mm	10 mm	13 mm
14	Set screw, shaft	Hexagonal Key	-	-	5 mm	6 mm
22	PERSWING P® air control system, cpl.	ALMATEC-Tool	enclosed		enclosed	

After loosening the housing bolts [12], the tension disc [4], the pump housings right hand [1] and left hand [3] can be taken away from the center housing [2]. To remove the diaphragms, unscrew them one diaphragm [5] carefully leftwards off the shaft [13] and pull the other diaphragm [5] together with the shaft [13] out of the center housing [2]. For CXM 50/55/130/135 only: Remove both parts of the shaft piston rings [15] from their grooves carefully (do not damage the edges in the center block; a re-assembly of the same piston rings is impossible; they have to be replaced).

For taking out the *PERSWING P*® air control system [22], first unscrew both end caps using the plastic mounting tool. Take out main and pilot piston, shove out the valve housing carefully using the tool as well. To install the air control system [22] again, first screw in one end cap flushly into the center housing [2]. Insert one of the six o-rings, air-valve housing [24] into the end cap from the inside. Moisture the four o-rings [24] of the air-valve housing with a bit of water and push the housing into the center housing using the mounting tool. Take care that it slips in softly. Do never insert the housing violently with a hammer. In case the housing cocks or hardly gets in, take it out again completely and start again. Insert the main piston and the pilot piston. Lay the sixth O-ring [24] on the edge of the air-valve housing and screw in the second end cap.

To re-install the diaphragms [5], fix one diaphragm onto the shaft [13] (for CXM 50/55 and CXM 130/135, first screw the set screws, shaft [15] into the diaphragms [5] and tighten them beforehand). Shove it into the center housing and fit the second diaphragm to the other end of the shaft. Adjust the bores in the center housing [2] to the diaphragms on both sides (turn slightly backwards if necessary). The sealing surfaces of the diaphragms [5] and the pump housings [1,3] have to be absolutely clean and undamaged; mere small scratches can cause leaking (if necessary, smoothen the housing surfaces carefully with fine sandpaper). Moisture all o-rings for assembly, push them in carefully, do not bend any ring.

When changing the product valves [9] take care that the axial bore-holes of the valve housing [8] are completely aligned with the holes in the side housings of the pump; check position after laying in the o-rings valve stop [11] and fixing the valve stops [10].

Push the tension disc [4] on the housing bolts [12] and fix the housing bolts crosswise evenly according to the given torque values (see page 11).

Before putting the pump back into operation, the tightness of the pump has to be checked.

Only use original ALMATEC spare parts for repairs and / or preventive maintenance work. If this is not observed, the CE and ATEX markings, the declaration of conformity (s) and the guarantee claim for the pump will expire.

All work on the pump may only be carried out with the appropriate tools and by trained specialist personnel.

TROUBLESHOOTING

Malfunction	Possible Reason	Solutions/Remarks
pump does not operate	air supply line blocked/closed muffler blocked working chambers blocked air control system defective discharge line blocked/closed	open air supply clean/replace muffler remove blockage replace air valve system clean/open line
pump operates unsteadily	piston rings worn air control system worn diaphragm rupture air control system soiled check valve blocked icing	replace piston rings replace air control system replace diaphragm, clean pump clean/replace air control system cleaning, removal of bulk particles improve air processing
air within liquid	suction line leaky container with liquid empty diaphragm rupture cavitation	seal suction line fill/new container replace diaphragm adapt suction lift, possibly install suction pressurised air chamber
insufficient discharge pressure	insufficient pressure/amount of driving air air supply line leaky air control system leaky check valve worn more air consuming components	increase air supply check/repair air supply replace air control system check/replace check valve increase pressure/amount of air
output decreases	air control system soiled icing air pressure drop suction line/inlet strainer soiled discharge line/outlet strainer soiled muffler blocked check valve worn change in viscosity more air consuming components	clean/replace air control system improve air processing: dryer/filter ensure sufficient supply of air cleaning cleaning replace the muffler replace valve change back/adjust pump increase pressure/amount of air
pump stops itself	icing of the air control system air pressure too low air pressure drop discharge line blocked air filter blocked valve closed air control system defective wear/leaking of air control system diaphragm rupture check valve blocked/worn	improve air processing: dryer/heater etc. increase air pressure ensure sufficient air supply clean discharge line clean air filter open valve replace air control system replace air control system replace diaphragm, clean pump clean/replace check valve

Malfunction	Possible Reason	Solutions/Remarks
pumps operates, however suction capacity insufficient	<p>pump operates too fast operation beyond physical limits cavitation operation beyond pump capacity</p> <p>air cushion within suction/discharge line dry suction against discharge pressure valve filter within suction line closed valve filter within discharge line closed container with liquid empty vacuum inside the container wear of the check valves suction line leaky suction line blocked air pressure cushion at discharge check valve blocked</p>	<p>start more slowly adjust installation check, cool down adjust installation resp. install bigger pump bleed the line wet pump, start without pressure open valve/clean filter open valve/clean filter fill/new container bleed container replace valves seal suction line clean suction line bleed discharge line clean/replace valve</p>
insufficient suction capacity after pump repair	<p>connections tighten incompletely check valves inserted falsely</p>	<p>tighten/seal connections correct positioning of check valves</p>
diaphragm overstrained	<p>pressure within the plant/system</p> <p>inadmissible vacuum icing</p>	<p>ensure that pressure is only developed by the pump itself, check plant/valves, replace diaphragms check suction line, open valve improve air processing</p>
leaking between housing parts	<p>housing bolts loosened O-rings sleeve damaged diaphragms attacked chemically diaphragms overstrained tension installation/pipework</p>	<p>tighten bolts, check pump replace O-rings replace diaphragms replace diaphragms loosen, eliminate tension, use of a compensator</p>
muffler grey	driving air too humid, icing	improve quality of driving air
muffler black	soiled, oily air	improve quality of driving air, install sensitive filter in suction line
pump is connected to air but does not operate	<p>air control system blocked bulk particles/dirt</p> <p>chemical influence (O-rings swollen) valve closed in discharge line</p>	<p>clean/replace air control system clean pump, replace necessary parts, improve air quality check, replace damaged parts open valve</p>
liquid leaves the pump via the muffler	diaphragm rupture	replace diaphragms, clean pump

SPARE PART LIST

Pump size				CXM 10	CXM 20/25	CXM 50/55	CXM 130/135	
Item	Qty.	Description	Material	Part number	Part number	Part number	Part number	
1	1	Pump housing, right hand	PE conductive	11 10 010 55	11 15 010 55	11 20 010 55	11 32 010 55	
2	1	Center housing, pump sizes 10/20/50/130	PE conductive	11 10 040 55	11 15 040 55	11 20 040 55	11 32 040 55	
		Center housing, pump sizes 25/55/135	PE conductive	-	11 15 140 55	11 20 140 55	11 32 140 55	
3	1	Pump housing left hand	PE conductive	11 10 011 55	11 15 011 55	11 20 011 55	11 32 011 55	
4	2	Tension disc	1.4301	7 08 008 22	7 10 008 22	4 20 008 22	4 32 008 22	
5	2	Diaphragm (code FE.)	EPDM	-	1 10 031 72	1 15 031 72	1 25 031 72	
		Diaphragm (code FN.)	NBR conductive	-	1 10 031 70	1 15 031 70	1 25 031 70	
		Diaphragm (code FT.)	PTFE/EPDM	1 08 031 67	1 10 031 67	1 15 031 67	1 25 031 67	
6	4	Sleeve	PE conductive	4 10 312 55	4 15 312 55	4 20 312 55	4 32 312 55	
7	4	O-ring, sleeve (code FE.)	EPDM	9 12 619 72	9 14 617 72	9 20 502 72	9 33 526 72	
		O-ring, sleeve (code FN.)	NBR	-	9 14 617 71	9 20 502 71	9 33 526 71	
		O-ring, sleeve (code FT.)	FEP / FKM	9 12 619 59	9 14 617 59	9 20 552 59	9 33 553 59	
8	2	Valve housing	PE conductive	11 10 014 55	11 15 014 55	11 20 014 55	11 32 014 55	
9	4	Valve ball (code F.E)	EPDM	1 10 032 72	4 15 032 72	1 15 032 72	1 25 032 72	
		Valve ball (code F.N)	NBR	-	4 15 032 71	1 15 032 71	1 25 032 71	
		Valve ball (code F.S)	Stainless steel	1 10 032 22	4 15 032 22	1 15 032 22	1 25 032 22	
		Valve ball (code F.T)	PTFE	1 10 032 60	4 15 032 60	1 15 032 60	1 25 032 60	
		Cylinder valve (code F.Z)	PE	4 10 313 52	4 15 313 52	4 20 313 52	4 32 313 52	
10	2	Valve stop	PE conductive	11 10 017 55	11 15 017 55	11 20 017 55	11 32 017 55	
11	2	O-ring, valve stop (code FE.)	EPDM	9 16 623 72	9 20 602 72	9 25 610 72	9 40 613 72	
		O-ring, valve stop (code FN.)	NBR	-	9 20 602 71	9 25 610 71	9 40 613 71	
		O-ring, valve stop (code FT.)	FEP / FKM	9 16 623 59	9 20 602 59	9 25 610 59	9 40 613 59	
12	*	<i>Housing bolt, cpl.</i>	<i>1.4305</i>	<i>4 10 220 22</i>	<i>4 15 220 22</i>	<i>4 20 220 22</i>	<i>4 32 220 22</i>	
13	1	<i>Shaft</i>	<i>1.4301</i>	<i>2 08 030 22**</i>	<i>2 08 030 22**</i>	<i>2 15 030 22</i>	<i>2 25 030 22</i>	
14	2	<i>Set screw, shaft</i>	<i>1.4305</i>	-	-	<i>9 10 220 22</i>	<i>9 12 221 22</i>	
15	2	<i>Shaft piston ring, cpl.</i>	<i>PTFE</i>	-	-	<i>1 15 041 64</i>	<i>1 25 041 64</i>	
16	1	<i>Muffler</i>	<i>PE</i>	<i>4 15 044 51</i>	<i>4 15 044 51</i>	<i>4 20 044 51</i>	<i>4 20 044 51</i>	
17	4	<i>Shock absorber</i>	<i>NR</i>	<i>1 08 022 85</i>	<i>1 15 022 85</i>	<i>1 15 022 85</i>	<i>1 15 022 85</i>	
22	1	<i>PERSWING P® air control system, cpl.</i>	<i>PETP</i>	<i>2 08 001 84</i>	<i>2 08 001 84</i>	<i>2 15 001 84</i>	<i>2 15 001 84</i>	
24**	6	<i>O-ring, air valve housing</i>	<i>NBR</i>	<i>9 26 519 71</i>	<i>9 26 519 71</i>	<i>9 35 504 71</i>	<i>9 35 504 71</i>	
* CXM 10/20/25: 4 pieces; CX 50/55/130/135: 6 pieces			** included in item 22					

All parts in italics are not product wetted.

Please see page 4 for explanation of the pump code.

When ordering please state the serial number of the pump.

SPECIAL EQUIPMENT FOR PUMPS WITH PTFE DIAPHRAGM

Code E: Pump equipped with PTFE diaphragms and EPDM gaskets

Pump size				CXM 10	CXM 20/25	CXM 50/55	CXM 130/135
Item	Qty.	Description	Material	Part number	Part number	Part number	Part number
7	4	O-ring sleeve	EPDM	9 12 619 72	9 14 617 72	9 20 502 72	9 33 526 72
11	2	O-ring, valve stop	EPDM	9 16 623 72	9 20 602 72	9 25 610 72	9 40 613 72

Code V: Pump equipped with PTFE diaphragms and FKM gaskets

Pump size				CXM 10	CXM 20/25	CXM 50/55	CXM 130/135
Item	Qty.	Description	Material	Part number	Part number	Part number	Part number
7	4	O-ring sleeve	FKM	9 12 619 74	9 14 617 74	9 20 502 74	9 33 526 74
11	2	O-ring, valve stop	FKM	9 16 623 74	9 20 602 74	9 25 610 74	9 40 613 74

Code L: Pump equipped with diaphragms made of PTFE conductive/EPDM compound

For the use of the pumps in the device group IIC without flanking measures diaphragms made of conductive PTFE/EPDM compound are available.

Pump size				CXM 10	CXM 20/25	CXM 50/55	CXM 130/135
Item	Qty.	Description	Material	Part number	Part number	Part number	Part number
5	2	Diaphragm	PTFE cond. /EPDM	-	-	1 15 031 68	1 25 031 68

Code P: Pump equipped with diaphragms made of modified PTFE/EPDM compound

For media with increased diffusion tendency (e.g. benzene, solvents) as well as for application with priming out of a vacuum PTFE/EPDM compound diaphragms made of modified PTFE are available.

Pump size				CXM 10	CXM 20/25	CXM 50/55	CXM 130/135
Item	Qty.	Description	Material	Part number	Part number	Part number	Part number
5	2	Diaphragm	PTFE mod. /EPDM	-	-	1 15 031 98	1 25 031 98

EXPLODED VIEWS

CXM 10 / CXM 20 / CXM 25

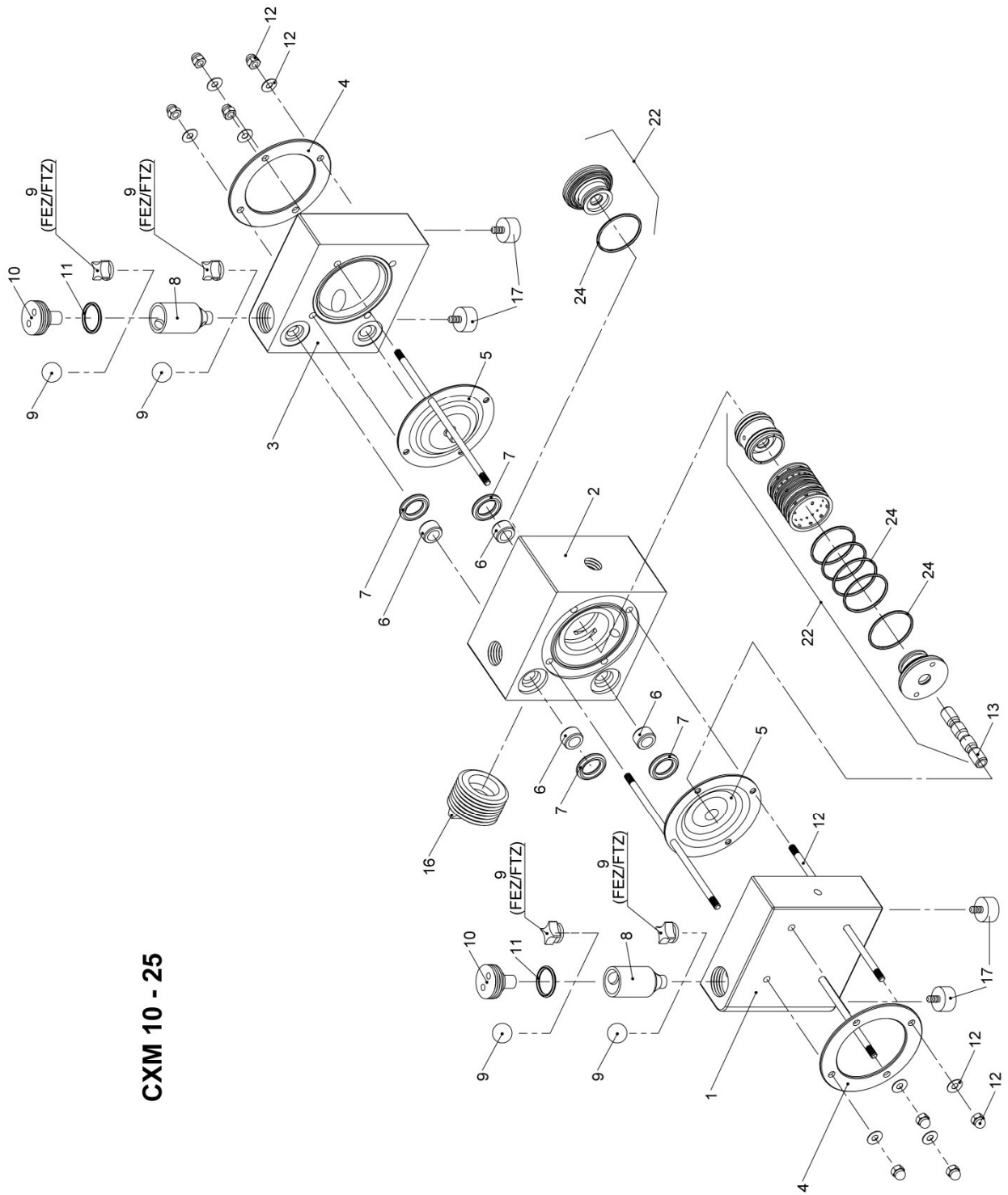

CXM 10 - 25

CXM 50 / CXM 55 / CXM 130 / CXM 135

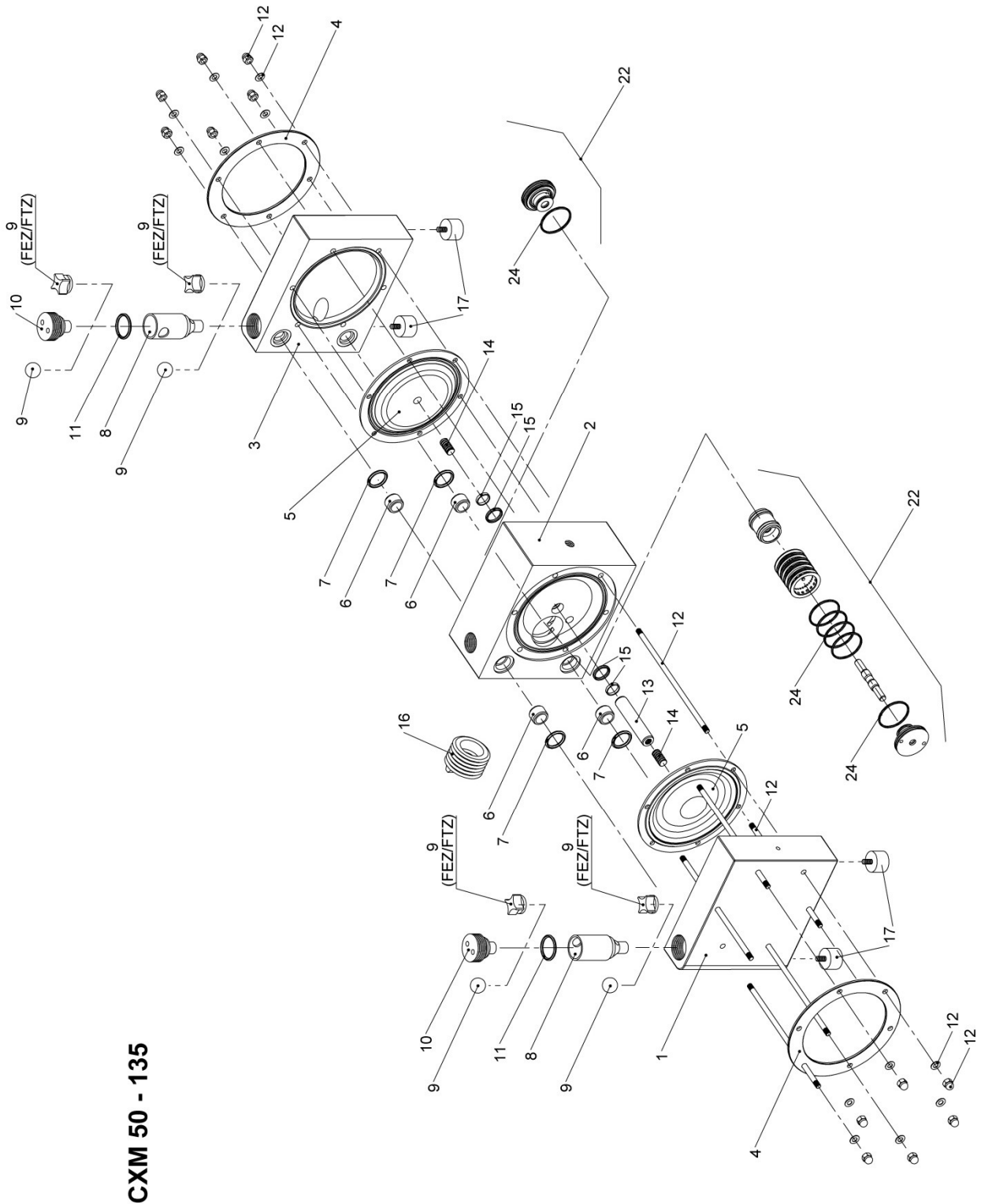

CXM 50 - 135



Subject to change without notice, 2021/07

PSG Germany GmbH
Hochstraße 150-152 · 47228 Duisburg · Germany
Telephone +49 (0) 20 65 / 89 2 05 - 0 · Telefax +49 (0) 20 65 / 89 2 05 - 40
<http://www.psgdover.com> · e-mail: psg-germany@psgdover.com